

## P/N 0E825002/6000

Manual hose reel in AISI 316 stainless steel s. 700, for water, oil, diesel and industrial fluids, 70 bar, without hose. Drum width 270 mm. Inlet-outlet G 2" (f)

### SECTORS OF USE

Industry, Mining, Lube trucks and transports

### FEATURES

Pressure	70 bar
Compatible fluids	water - oils - diesel fuel - industrial fluid
Swivel joint	AISI 316 stainless steel
Seals	Viton®
Characteristic	manual
Material	AISI 316 stainless steel
Couplings	-
Hose	-
Ø e hose length	-
Inlet	G 2" (f)
Outlet	G 2" (f)
Reel flow path	AISI 316 stainless steel



### OVERALL DIMENSIONS (mm)

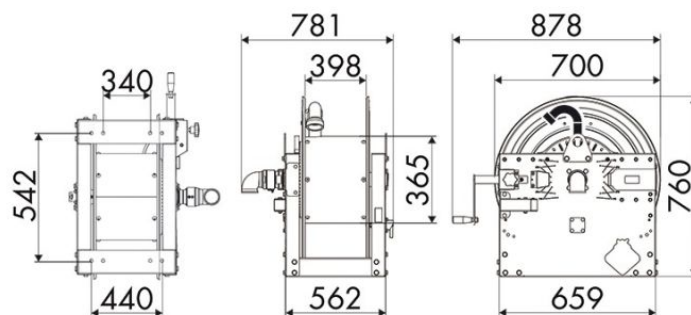

### FURTHER FEATURES

Capacity 3/8"	Capacity 1/2"	Capacity 3/4"	Capacity 1"	Capacity 1.1/4"	Capacity 1.1/2"	Capacity 2"
160 m	110 m	65 m	30 m	20 m	15 m	10 m